

colours.
textures.
trends.

Stockgamma.
Gamme de stock.
Stock range.
Lagerprogramm.



SOAP
SHOP



Stockgamma. Gamme de stock. Stock range. Lagerprogramm.



Gemelamineerde spaanplaat / Panneau de particules mélaminé /
Melamine faced chipboard / Melaminharzbeschichtete Spanplatte
2800x2070x18mm - 2800x2070x19mm



Gemelamineerde spaanplaat / Panneau de particules mélaminé /
Melamine faced chipboard / Melaminharzbeschichtete Spanplatte
2500x1250x18mm



HPL / Stratifié HPL / HPL / Schichtstoff
3050x1300x0,7mm



HPL / Stratifié HPL / HPL / Schichtstoff
2150x950x0,7mm



Melamine kantenband / Bande de chant mélaminé / Melamine edgebanding / Melaminkanten - 23x0,35mm
Voorgelijmd / Pré-encollée / Preglued / Mit Schmelzkleber (50m/rl)
Ongelijmd / Non-encollée / Unglued / Ohne Schmelzkleber (100m/rl)



ABS kantenband / Bande de chant ABS / ABS edgebanding / ABS Kanten
23x1 mm (75m/rl) - 23x2mm (75m/rl)



ClicWall
2785x618x10mm (gross) - 2785x600x10mm (net)



Meubelpanelen / Tablettes / Shelving / Möbelbauplatten
2500x400x18mm - 2500x600x18mm

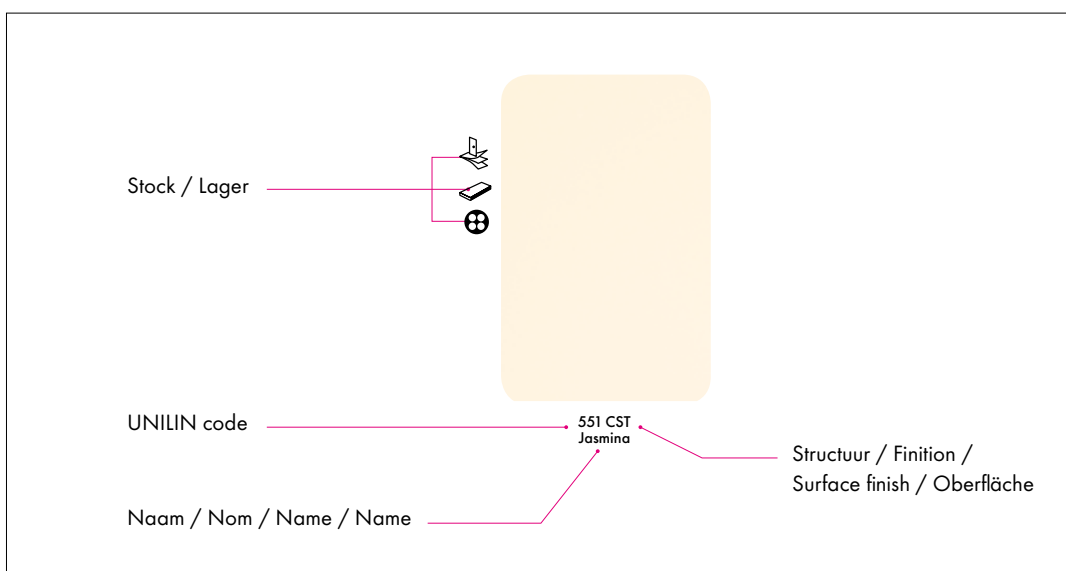
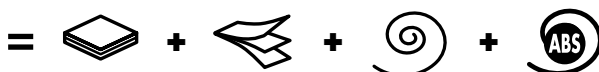



| | | | | | | | | | |
|--|--|--|--|--|--|--|--|--|--|
| | | | | | | | | | |
| | | | | | | | | | |
| | | | | | | | | | |
| | | | | | | | | | |
| | | | | | | | | | |
| | | | | | | | | | |
| | | | | | | | | | |
| | | | | | | | | | |



H455 W04
Flakewood painted white



H163 BST
Flakewood white



H425 W03
Rena Pine

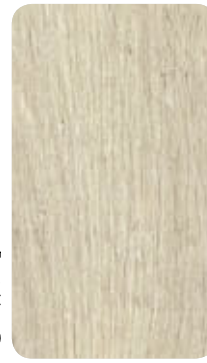

H780 W06
Romantic Oak light

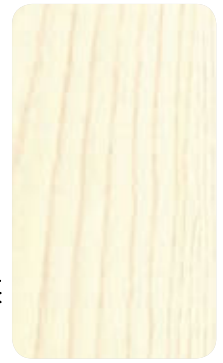

H362 BST
Suomi Ash



H843 BST
Snowdon Oak



H866 BST
Everest Oak



H448 W04
Nordic Pine light natural



944 CST
Modena Apple

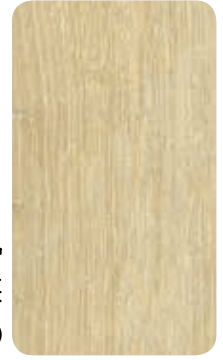

H784 W06
Robinson Oak light natural



H450 V9A
Heritage Oak light patina



H877 BST
Venamo Oak



H447 W04
Nordic Pine natural



H851 BST
Atlas Oak

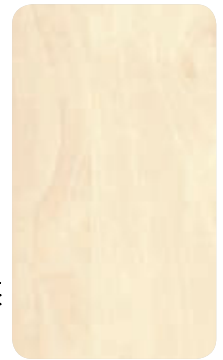

H720 BST
White Birch



H787 W05
Desert brushed Oak grey



H452 W04
Emilia Oak light grey



H451 W04
Emilia Oak natural

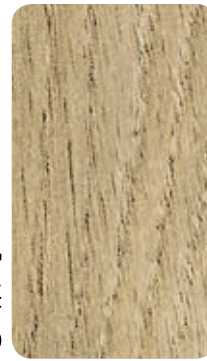

H162 Z5L
Minnesota Oak natural



H534 BST
Odessa Beech



H161 V9A
Heritage Oak light



H387 BST
Marne Oak



H864 BST
Fiji Oak



766 CST
Natural Oak



H842 BST
Eiger Walnut



H337 BST
Pearl Oak



H788 W05
Desert brushed Oak natural



H397 BST
Robson Oak



H847 BST
Allegro Beech light



H320 BST
Belisio Oak



H785 W06
Robinson Oak beige



H852 W03
Essential Oak natural



H399 W03
Canice Oak



H863 BST
Etna Oak



H339 BST
Solara Oak



H781 W06
Romantic Oak honey natural



H327 BST
Oak Rustique



H581 BST
Aneto Walnut



H588 V8A
Royal Oak vanille



747 CST
Jura Beech



H878 BST
Paruma Oak



H440 Z5L
Minnesota Oak warm natural



H561 BST
Italian Walnut



H868 BST
Rila Oak



H782 W06
Romantic Oak brown



H437 V8A
Royal Oak natural



H562 BST
Arabica Walnut



H786 W06
Robinson Oak brown



H783 W06
Romantic Oak dark grey



H789 W05
Desert brushed Oak black brown



H892 BST
Logan Oak



H876 BST
Todi Oak



H454 W04
Flakewood taupe



H453 W04
Emilia Oak dark grey



H865 BST
Sinai Oak



H336 BST
Verona Oak



H160 Z5L
Minnesota Oak greige



H853 BST
Riverside Oak



H335 BST
Torino Oak



H378 BST
Garonne Oak



H689 W03
Amazonia



H582 BST
Dinara Walnut



H891 BST
Delano Oak



H338 CST
Granada Oak



H438 V9A
Heritage Oak medium brown



H164 V8A
Royal Oak dark brown



H449 W04
Nordic Pine grey brown



H439 V9A
Heritage Oak dark



H844 BST
Bellavista Oak



H687 CST
Kivu Wenge



H894 W03
Nevis Oak



F988 W04
Raw Concrete light beige



760 CST
Brushed Alu



F939 CST
Brushed Metal



H441 Z5L
Minnesota Oak chocolat



F989 BST
Pure Concrete light



F976 BST
Granulo



760 M01
Brushed Alu



H385 W03
Hudson Oak



F985 W04
Raw Concrete grey



F981 CST
Woven



F994 M01
Brushed gold



H850 CST
Fumed Oak



F986 W04
Raw Concrete dark grey



F984 CST
Blue jeans



F992 M01
Brushed bronze



F987 CST
Oxid grey



F993 M01
Brushed steel blue

Structuren.
Finitions.
Surface finishes.
Oberflächen.



BST - Topmat



CST - Soft Pearl



W03 - Linewood



W04 - Deepwood



W05 - Brushed wood



W06 - Veneer wood



V8A - Royal Oak



V9A - Heritage Oak



Z5L - Minnesota Oak



M01 - Metallic

SYNC:

Synchrone oppervlaktestructuur - De structuur volgt perfect de tekening van het hout
Finition de surface synchrone - La structure suit parfaitement le motif du bois
Synchronised surface structure - The structure follows the design of the wood perfectly
Synchrone Oberflächenstruktur - Die Struktur folgt perfekt dem Design des Holzes

Productoverzicht.
Aperçu des produits.
Product overview.
Produktübersicht.



| UNILIN code | Naam Nom Name Name | Structuur Finition Surface finish Oberfläche | Gemelamineerde spaanplaat Panneau de particules mélaminé Melamine faced chipboard Melaminharzbeschichtete Spanplatte | | HPL Stratifié HPL High Pressure Laminate Schichtstoff | | Kantenband Bande de chant Edging tape Kantenbänder | | | | Meubel- panelen Tablettes Shelving Möbel- bauplatten | Prijnsindicatie Price indication Indication de prix Preishinweis | | |
|-------------|-----------------------------|---|---|----------------|--|------------|---|---|---------------------------|---------------------------|---|---|--------------------------------|----------|
| | | | 2800x2070x18mm 2800x2070x19mm | 2500x1250x18mm | 3050x1300mm | 2150x950mm | MEL 23x0,35mm (50m/rl) voorgelijmd pre-glued mit Schmelzkleber | MEL 23x0,35mm (100 m/rl) ongelijmd non-collée ohne Schmelzkleber | ABS 23x1mm (75m/rl) | ABS 23x2mm (75m/rl) | | ABS 23x1mm (75m/rl) Kops Bois de bout End grain Hinterholz | 2500x400x18mm 2500x600x18mm | ClicWall |
| 020 | Basic white | CST | • | • | • | • | • | • | • | • | | | * | * |
| 025 | Front white | CST | • | • | • | • | • | • | • | • | | • | * | * |
| 025 | Front white | W03 | • | | • | • | • | • | • | • | | • | ** | ** |
| 113 | Elegant black | CST | • | • | • | • | • | • | • | • | • | | ** | ** |
| 113 | Elegant black | W03 | • | | • | • | • | • | • | • | | | ** | ** |
| 113 | Elegant black | W04 | • | | • | • | • | • | • | • | | | ** | ** |
| 113 | Elegant black | W06 | • | | • | • | • | • | • | • | • | | ** | ** |
| 551 | Jasmina | CST | • | • | • | • | • | • | • | • | • | | ** | ** |
| 625 | Silicon | BST | • | | • | • | • | • | • | • | • | | ** | ** |
| 625 | Silicon | CST | • | • | • | • | • | • | • | • | • | • | ** | ** |
| 625 | Silicon | W04 | • | | • | • | • | • | • | • | • | | ** | ** |
| 625 | Silicon | W05 | • | • | • | • | • | • | • | • | • | | ** | ** |
| 747 | Jura Beech | CST | • | | • | • | • | • | • | • | • | | ** | ** |
| 760 | Brushed Alu | CST | • | • | • | • | • | • | • | • | • | | ** | ** |
| 760 | Brushed Alu | M01 | • | | • | • | • | • | • | • | • | | ** | ** |
| 766 | Natural Oak | CST | • | • | • | • | • | • | • | • | • | | ** | ** |
| 944 | Modena Apple | CST | • | | • | • | • | • | • | • | • | | ** | ** |
| F939 | Brushed Metal | CST | • | | • | • | • | • | • | • | • | | ** | ** |
| F976 | Granulo | BST | • | | • | • | • | • | • | • | • | | ** | ** |
| F981 | Woven | CST | • | | • | • | • | • | • | • | • | | ** | ** |
| F984 | Blue jeans | CST | • | | • | • | • | • | • | • | • | | ** | ** |
| F985 | Raw Concrete grey | W04 | • | | • | • | • | • | • | • | • | | ** | ** |
| F986 | Raw Concrete dark grey | W04 | • | | • | • | • | • | • | • | • | | ** | ** |
| F987 | Oxid grey | CST | • | | • | • | • | • | • | • | • | | ** | ** |
| F988 | Raw Concrete light beige | W04 | • | | • | • | • | • | • | • | • | | ** | ** |
| F989 | Pure Concrete light | BST | • | | • | • | • | • | • | • | • | • | ** | ** |
| F992 | Brushed bronze | M01 | • | | • | • | • | • | • | • | • | | ** | ** |
| F993 | Brushed steel blue | M01 | • | | • | • | • | • | • | • | • | | ** | ** |
| F994 | Brushed gold | M01 | • | | • | • | • | • | • | • | • | | ** | ** |
| H160 | Minnesota Oak greige | Z5L | • | | • | • | • | • | • | • | • | | ** | ** |
| H161 | Heritage Oak light | V9A | • | | • | • | • | • | • | • | • | | ** | ** |
| H162 | Minnesota Oak natural | Z5L | • | | • | • | • | • | • | • | • | | ** | ** |
| H163 | Flakewood white | BST | • | | • | • | • | • | • | • | • | • | ** | ** |
| H164 | Royal Oak dark brown | V8A | • | | • | • | • | • | • | • | • | | ** | ** |
| H320 | Belisio Oak | BST | • | | • | • | • | • | • | • | • | | ** | ** |
| H327 | Oak Rustique | BST | • | • | • | • | • | • | • | • | • | | ** | ** |
| H335 | Torino Oak | BST | • | | • | • | • | • | • | • | • | | ** | ** |
| H336 | Verona Oak | BST | • | | • | • | • | • | • | • | • | | ** | ** |
| H337 | Pearl Oak | BST | • | • | • | • | • | • | • | • | • | | ** | ** |
| H338 | Granada Oak | CST | • | | • | • | • | • | • | • | • | | ** | ** |
| H339 | Solara Oak | BST | • | | • | • | • | • | • | • | • | | ** | ** |
| H362 | Suomi Ash | BST | • | | • | • | • | • | • | • | • | | ** | ** |
| H378 | Garonne Oak | BST | • | • | • | • | • | • | • | • | • | • | ** | ** |
| H385 | Hudson Oak | W03 | • | | • | • | • | • | • | • | • | | ** | ** |
| H387 | Marne Oak | BST | • | | • | • | • | • | • | • | • | | ** | ** |
| H397 | Robson Oak | BST | • | • | • | • | • | • | • | • | • | | ** | ** |
| H399 | Canice Oak | W03 | • | | • | • | • | • | • | • | • | | ** | ** |
| H425 | Rena Pine | W03 | • | | • | • | • | • | • | • | • | | ** | ** |
| H437 | Royal Oak natural | V8A | • | | • | • | • | • | • | • | • | | ** | ** |
| H438 | Heritage Oak medium brown | V9A | • | | • | • | • | • | • | • | • | | ** | ** |
| H439 | Heritage Oak dark | V9A | • | | • | • | • | • | • | • | • | | ** | ** |
| H440 | Minnesota Oak warm natural | Z5L | • | | • | • | • | • | • | • | • | | ** | ** |
| H441 | Minnesota Oak chocolat | Z5L | • | | • | • | • | • | • | • | • | | ** | ** |
| H447 | Nordic Pine natural | W04 | • | | • | • | • | • | • | • | • | | ** | ** |
| H448 | Nordic Pine light natural | W04 | • | | • | • | • | • | • | • | • | | ** | ** |
| H449 | Nordic Pine grey brown | W04 | • | | • | • | • | • | • | • | • | | ** | ** |
| H450 | Heritage Oak light patina | V9A | • | | • | • | • | • | • | • | • | • | ** | ** |
| H451 | Emilia Oak natural | W04 | • | | • | • | • | • | • | • | • | | ** | ** |
| H452 | Emilia Oak light grey | W04 | • | | • | • | • | • | • | • | • | | ** | ** |
| H453 | Emilia Oak dark grey | W04 | • | | • | • | • | • | • | • | • | | ** | ** |
| H454 | Flakewood taupe | W04 | • | | • | • | • | • | • | • | • | | ** | ** |
| H455 | Flakewood painted white | W04 | • | | • | • | • | • | • | • | • | | ** | ** |

Productoverzicht.
Aperçu des produits.
Product overview.
Produktübersicht.



| UNILIN code | Naam Nom Name Name | Structuur Finition Surface finish Oberfläche | Gemelamineerde spaanplaat Panneau de particules mélaminé Melamine faced chipboard Melaminharzbeschichtete Spanplatte | | HPL Stratifié HPL High Pressure Laminate Schichtstoff | | Kantenband Bande de chant Edging tape Kantenbänder | | | | Meubel- panelen Tablettes Shelving Möbel- bauplatten | Prijnsindicatie Price indication Indication de prix Preishinweis | | |
|-------------|-----------------------------|---|---|----------------|--|------------|--|--|---------------------------|---------------------------|---|---|--------------------------------|-----------|
| | | | 2800x2070x18mm 2800x2070x19mm | 2500x1250x18mm | 3050x1300mm | 2150x950mm | MEL 23x0,35mm (50m/rl) voorgelijmd pré-encollé pre-glued mit Schmelzkleber | MEL 23x0,35mm (100m/rl) ongelijmd non-encollé unglued ohne Schmelzkleber | ABS 23x1mm (75m/rl) | ABS 23x2mm (75m/rl) | | ABS 23x1mm (75m/rl) Kops Bois de bout End grain Hirnholz | 2500x400x18mm 2500x600x18mm | ClickWall |
| H534 | Odessa Beech | BST | • | | • | | • | • | • | • | | | • | • |
| H561 | Italian Walnut | BST | • | | • | | • | • | • | • | | | • | • |
| H562 | Arabica Walnut | BST | • | | • | | • | • | • | • | | | • | • |
| H581 | Aneto Walnut | BST | • | | • | | • | • | • | • | | | • | • |
| H582 | Dinara Walnut | BST | • | | • | | • | • | • | • | | | • | • |
| H588 | Royal Oak vanille | V8A | • | | • | | • | • | • | • | • | • | • | • |
| H687 | Kivu Wenge | CST | • | | • | | • | • | • | • | | | • | • |
| H689 | Amazonia | W03 | • | | • | | • | • | • | • | | | • | • |
| H720 | White Birch | BST | • | | • | • | • | • | • | • | | | • | • |
| H780 | Romantic Oak light | W06 | • | | • | | • | • | • | • | | | • | • |
| H781 | Romantic Oak honey natural | W06 | • | | • | | • | • | • | • | | | • | • |
| H782 | Romantic Oak brown | W06 | • | | • | | • | • | • | • | | | • | • |
| H783 | Romantic Oak dark grey | W06 | • | | • | | • | • | • | • | | | • | • |
| H784 | Robinson Oak light natural | W06 | • | | • | | • | • | • | • | | | • | • |
| H785 | Robinson Oak beige | W06 | • | | • | | • | • | • | • | | • | • | • |
| H786 | Robinson Oak brown | W06 | • | | • | | • | • | • | • | | • | • | • |
| H787 | Desert brushed Oak grey | W05 | • | | • | | • | • | • | • | | | • | • |
| H788 | Desert brushed Oak natural | W05 | • | | • | | • | • | • | • | | | • | • |
| H789 | Desert brushed Oak black | W05 | • | | • | | • | • | • | • | | | • | • |
| H842 | Eiger Walnut | BST | • | | • | • | • | • | • | • | | | • | • |
| H843 | Snowdon Oak | BST | • | | • | • | • | • | • | • | | | • | • |
| H844 | Bellavista Oak | BST | • | | • | | • | • | • | • | | | • | • |
| H847 | Allegro Beech light | BST | • | | • | | • | • | • | • | | | • | • |
| H850 | Fumed Oak | CST | • | | • | | • | • | • | • | | | • | • |
| H851 | Atlas Oak | BST | • | • | • | | • | • | • | • | | • | • | • |
| H852 | Essential Oak natural | W03 | • | | • | | • | • | • | • | | | • | • |
| H853 | Riverside Oak | BST | • | | • | | • | • | • | • | | | • | • |
| H863 | Etna Oak | BST | • | | • | | • | • | • | • | | | • | • |
| H864 | Fiji Oak | BST | • | | • | | • | • | • | • | | | • | • |
| H865 | Sinai Oak | BST | • | | • | | • | • | • | • | | | • | • |
| H866 | Everest Oak | BST | • | | • | | • | • | • | • | | | • | • |
| H868 | Rila Oak | BST | • | | • | • | • | • | • | • | | • | • | • |
| H876 | Todi Oak | BST | • | | • | | • | • | • | • | | | • | • |
| H877 | Venamo Oak | BST | • | • | • | | • | • | • | • | | • | • | • |
| H878 | Paruma Oak | BST | • | | • | • | • | • | • | • | | | • | • |
| H891 | Delano Oak | BST | • | | • | | • | • | • | • | | | • | • |
| H892 | Logan Oak | BST | • | | • | | • | • | • | • | | | • | • |
| H894 | Nevis Oak | W03 | • | | • | | • | • | • | • | | | • | • |
| U115 | Dark ecru | CST | • | • | • | | • | • | • | • | | | • | • |
| U115 | Dark ecru | W04 | • | | • | | • | • | • | • | | | • | • |
| U115 | Dark ecru | W05 | • | • | • | | • | • | • | • | | | • | • |
| U127 | Dune beige | CST | • | | • | | • | • | • | • | | • | • | • |
| U128 | Stone grey | CST | • | | • | | • | • | • | • | | | • | • |
| U128 | Stone grey | W04 | • | | • | | • | • | • | • | | | • | • |
| U129 | Shadow | CST | • | | • | | • | • | • | • | | | • | • |
| U130 | Shady brown | CST | • | | • | | • | • | • | • | | | • | • |
| U135 | Amber yellow | CST | • | | • | | • | • | • | • | | | • | • |
| U136 | Sunshine | CST | • | | • | | • | • | • | • | | | • | • |
| U137 | Candy red | CST | • | | • | | • | • | • | • | | | • | • |
| U139 | Plum purple | CST | • | | • | | • | • | • | • | | | • | • |
| U140 | Purple jam | CST | • | | • | | • | • | • | • | | | • | • |
| U141 | Evening red | CST | • | | • | | • | • | • | • | | | • | • |
| U142 | Exotic blue | CST | • | | • | | • | • | • | • | | | • | • |
| U143 | Fresh green | CST | • | | • | | • | • | • | • | | | • | • |
| U146 | Cloud grey | CST | • | • | • | | • | • | • | • | | | • | • |
| U147 | Seashell | BST | • | | • | | • | • | • | • | | | • | • |
| U147 | Seashell | CST | • | • | • | • | • | • | • | • | | • | • | • |
| U147 | Seashell | W04 | • | | • | | • | • | • | • | | | • | • |
| U147 | Seashell | W05 | • | • | • | | • | • | • | • | | | • | • |
| U148 | Teal | CST | • | | • | | • | • | • | • | | | • | • |
| U149 | Pale green | CST | • | | • | | • | • | • | • | | | • | • |
| U150 | Ink blue | CST | • | | • | | • | • | • | • | | | • | • |

Productoverzicht. Aperçu des produits. Product overview. Produktübersicht.



| UNILIN code | Naam Nom Name Name | Structuur Finition Surface finish Oberfläche | Gemelamineerde spaanplaat Panneau de particules mélaminé Melamine faced chipboard Melaminharzbeschichtete Spanplatte | | HPL Stratifié HPL High Pressure Laminate Schichtstoff | | Kantenband Bande de chant Edging tape Kantenbänder | | | | | Meubel- panelen Tablettes Shelving Möbel- bauplatten | Prijsindicatie Price indication Indication de prix Preishinweis | | |
|-------------|-----------------------------|---|---|----------------|--|------------|---|---|---------------------------|---------------------------|--|---|--|-----------------|-----------------|
| | | | 2800x2070x18mm 2800x2070x19mm | 2500x1250x18mm | 3050x1300mm | 2150x950mm | MEL 23x0,35mm (50m/rl) voorgelijmd pre-glued mit Schmelzkleber | MEL 23x0,35mm (100 m/rl) ongelijmd non-collée ohne Schmelzkleber | ABS 23x1mm (75m/rl) | ABS 23x2mm (75m/rl) | ABS 23x1mm (75m/rl) Kops Bois de bout End grain Hinterholz | 2500x400x18mm 2500x600x18mm | ClicWall | MEL 2800x2070mm | HPL 3050x1300mm |
| U172 | Ivory | CST | • | | • | | • | • | • | • | | | • | • | • |
| U178 | Mineral grey | CST | • | | • | | • | • | • | • | | | • | • | • |
| U222 | Rice paper | CST | • | | • | | • | • | • | • | • | | • | • | • |
| U265 | Persian blue | CST | • | | • | | • | • | • | • | | | • | • | • |
| U271 | Misty grey | CST | • | | • | | • | • | • | • | | | • | • | • |
| U272 | Tiger orange | CST | • | | • | | • | • | • | • | | | • | • | • |
| U279 | Goldfish orange | CST | • | | • | | • | • | • | • | | | • | • | • |
| U282 | Fondant | CST | • | | • | | • | • | • | • | | | • | • | • |
| U284 | Mokka | CST | • | | • | | • | • | • | • | | | • | • | • |
| U285 | Lemon | CST | • | | • | | • | • | • | • | | | • | • | • |
| U287 | Mojave | CST | • | | • | | • | • | • | • | | | • | • | • |
| U288 | Choco | CST | • | | • | | • | • | • | • | | | • | • | • |
| U292 | Turtle grey | CST | • | | • | | • | • | • | • | | | • | • | • |
| U292 | Turtle grey | W04 | • | | • | | • | • | • | • | | | • | • | • |
| U640 | Lychee | CST | • | | • | | • | • | • | • | | | • | • | • |
| U641 | Indian curry | CST | • | | • | | • | • | • | • | | | • | • | • |
| U642 | Macchiato brown | CST | • | | • | | • | • | • | • | | | • | • | • |
| U643 | Cognac | CST | • | | • | | • | • | • | • | | | • | • | • |
| U644 | Coffee brown | CST | • | | • | | • | • | • | • | | | • | • | • |
| U645 | Industrial green | CST | • | | • | | • | • | • | • | | | • | • | • |
| U646 | Cloverfield green | CST | • | | • | | • | • | • | • | | | • | • | • |
| U647 | Frozen blue | CST | • | | • | | • | • | • | • | | | • | • | • |
| U648 | Silver blue | CST | • | | • | | • | • | • | • | | | • | • | • |
| U649 | Electric blue | CST | • | | • | | • | • | • | • | | | • | • | • |
| U650 | Tea leaf | CST | • | | • | | • | • | • | • | | | • | • | • |
| U651 | Smoothie green | CST | • | | • | | • | • | • | • | | | • | • | • |
| U652 | Olive cream | CST | • | | • | | • | • | • | • | | | • | • | • |
| U653 | Green shadow | CST | • | | • | | • | • | • | • | | | • | • | • |
| U654 | Coral | CST | • | | • | | • | • | • | • | | | • | • | • |
| U655 | Mushroom beige | CST | • | | • | | • | • | • | • | | | • | • | • |
| U656 | Tanned peach | CST | • | | • | | • | • | • | • | | | • | • | • |
| UD26 | Elephant grey | CST | • | • | • | • | • | • | • | • | | | • | • | • |
| UD26 | Elephant grey | W04 | • | | • | | • | • | • | • | | | • | • | • |
| UD26 | Elephant grey | W05 | • | • | • | • | • | • | • | • | | | • | • | • |
| UD59 | Creamy | CST | • | | • | | • | • | • | • | | | • | • | • |
| UD81 | Quartz | CST | • | • | • | • | • | • | • | • | | | • | • | • |
| WA12 | Azure white | CST | • | • | • | • | • | • | • | • | | | • | • | • |
| WA12 | Azure white | W04 | • | | • | | • | • | • | • | | | • | • | • |
| WA12 | Azure white | W05 | • | • | • | • | • | • | • | • | | | • | • | • |
| WE26 | Pebble white | BST | • | | • | | • | • | • | • | | | • | • | • |
| WE26 | Pebble white | CST | • | • | • | • | • | • | • | • | | | • | • | • |
| WE27 | Lace white | CST | • | | • | | • | • | • | • | | | • | • | • |
| WE28 | Everest white | BST | • | | • | | • | • | • | • | | | • | • | • |
| WE28 | Everest white | CST | • | • | • | • | • | • | • | • | | | • | • | • |

De verstrekte informatie is correct op het moment van publicatie, maar ons beleid is om continu onze producten uit te breiden en te verbeteren en we verwachten veranderingen te maken in de toekomst. De afbeeldingen dienen als indicatie voor de kleur en kunnen afwijken van het uiteindelijke product. Vraag een gratis staal aan voordat u een definitieve selectie maakt.

Les informations fournies sont exactes au moment de la publication, mais notre politique d'expansion continue et d'amélioration de nos produits font que nous nous attendons à faire des changements dans l'avenir. Les images sont une représentation de la couleur et ils peuvent différer du produit final. Commandez un échantillon gratuit avant de faire votre commande.

The information provided is correct at the time of publication but our policy is one of continuous product expansion and improvement and we expect to make changes in the future. The images are a representation of the colour and may vary from the actual final product. Order a free sample prior to making your final selection.

Diese Informationen gelten zum Zeitpunkt der Veröffentlichung. Bitte beachten Sie, daß unsere Produktpolitik ständige Produktentwicklung und Kollektionserweiterung vorsieht und sich diese Informationen somit ändern können. Diese abbildungen sind eine Darstellung der Farbe, die jedoch etwas vom tatsächlichen Endprodukt abweichen kann. Sehen Sie sich, bevor Sie sich endgültig entscheiden, bitte ein Muster an.

Stalenservice.

Graag een staal ontvangen?
Vraag ze aan op www.unilinpanels.com

Service d'échantillons.

Vous souhaitez recevoir un échantillon?
Demandez-le sur www.unilinpanels.com

Sample service.

Would you like to receive a sample?
Simply order it via www.unilinpanels.com

Musterservice.

Würden Sie gerne ein Muster erhalten?
Wenden Sie sich diesbezüglich an uns über
www.unilinpanels.com

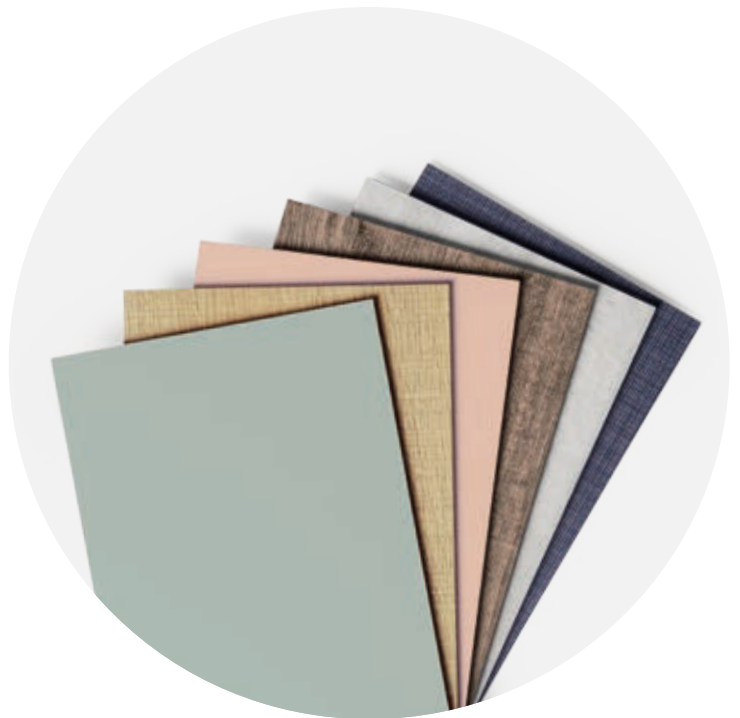

UNILIN, division panels

Ingelmunstersteenweg 229
8780 Oostrozebeke
Belgium
T +32 56 66 70 21

info.panels@unilin.com
www.unilinpanels.com